

**WARRANTY
REGISTRATION**
Register online today for a chance
to win a FREE Tripp Lite product!
www.tripplite.com/warranty



Owner's Manual

PowerVerter®
APS Series

DC-to-AC Inverter/Chargers



1111 W. 35th Street, Chicago, IL 60609 USA
Customer Support: (773) 869-1234
www.tripplite.com

	Input	Output
Invert:	12, 24, 36 or 48 VDC	120V, 60 Hz. AC
Charge:	120V, 60 Hz. AC	12, 24, 36 or 48 VDC

Reliable Emergency Backup Power

Congratulations! You've purchased the most advanced, feature-rich Inverter/Charger designed as an alternative energy source during utility power failures. Tripp Lite APS Inverter/Chargers keep your equipment constantly up and productive through all utility power problems (blackouts, brownouts and high voltages) by inverting DC power from user-supplied batteries into AC power. Built-in surge suppression provides an additional level of equipment protection. When utility power is present, APS Inverter/Chargers automatically pass through power to your equipment while simultaneously recharging your connected battery bank. APS Inverter/Chargers are the quiet alternative to gas generators during emergency backup applications—with no fumes, fuel or noise to deal with! You get AC electricity anywhere and anytime you need it.

Better for Your Equipment

Premium Protection Levels

- Built-In Isobar® Surge Protection
- Automatic Overload Protection

Ideal Output for All Loads (including computers)

- Frequency-Controlled Output
- Fast Load Switching
- Balanced Load Sharing*

Better for Your Batteries

Faster Battery Recharge

- High-Amp, 3-Stage Battery Charger (adjustable)

Critical Battery Protection

- Battery Charge Conserver (Load Sense)*
- Battery Temperature Sensing*
- High-Efficiency DC-to-AC Inversion

Better for You

Simple, Maintenance-Free Operation

- Multi-Function Lights & Switches
- Moisture-Resistant Construction**

Contents

Specifications	2	Mounting	9
Safety	3	Battery Connection	10
Feature Identification	4	AC Input/Output Connection	11
Operation	5	Service/Maintenance	11
Configuration	6-7	Troubleshooting/Warranty	12
Battery Selection	8	Español	13

* Available on all models except 612 models. ** Inverter/Chargers are moisture-resistant, not waterproof.
Copyright © 2007. PowerVerter® is a registered trademark of Tripp Lite. All rights reserved.

Specifications

MODEL NUMBER: AC Input Connection:	APS612 Input Cord	APS1012 Input Cord	APS1524 Hardwire	APS2012 Hardwire	APS2424 Hardwire	APS2448 Hardwire	APS3624VR Hardwire	APS3636VR Hardwire
Continuous Power (@ 20 C):	600	1000	1500	2000	2400	2400	3600	3600
OverPower™ Peak Surge Power:**	900	1500	2250	3000	3600	3600	5400	5400
Double Boost™ Peak Surge Power:**	1200	2000	3000	4000	4800	4800	7200	7200
DC Input Volts (Nominal):	12 VDC	12 VDC	24 VDC	12 VDC	24 VDC	48 VDC	24 VDC	36 VDC
DC Input Voltage Range:	10-15 VDC	10-15 VDC	20-30 VDC	10-15 VDC	20-30 VDC	40-60 VDC	20-30 VDC	30-45 VDC
Minimum DC Fuse Rating:	100 A	225 A	125 A	400 A	300 A	100 A	300 A	300 A
DC Input Current @ Nominal V DC Full Load	56 A	95 A	70 A	192 A	112 A	56 A	170 A	114 A

BATTERY CHARGER

Common Specifications for All Models • Input Volts (Nominal): 120 VAC	
Charging Capacity DC:	20 A
Acceptance Volts VDC: Selectable (Wet**/Gel)	14.4 V/14.2 V
Floot Volts VDC (w/gel):	13.3 V (13.6 V)
Input Current AC (Maximum):	4.2 A

LINE VAC OPERATION

Common Specifications for All Models • Minimum Input Volts (Transfer to Battery): Selectable 75, 85, 95 or 105 VAC • Maximum Input Volts (Transfer to Battery): Selectable 135** or 145 VAC • Input Frequency (Nominal): 60 Hz, ±10%	
Total Input AC Current (Continuous, Charger at Maximum):	9.2 A
Maximum Output Current (Continuous):	5 A

* OverPower duration (up to 1 hour). DoubleBoost duration (up to 10 seconds). Actual duration depends on battery age, battery charge level and ambient temperature. ** Factory setting. The policy of Tripp Lite is one of continuous improvement. Specifications are subject to change without notice.

Minimum Recommended Cable Sizing Charts*

Use in conjunction with DC wiring connection instructions in the Battery Connection section.

Inverter/Charger DC Volt: 12

Watts	Wire Gauge			
	6	4	2	0 (2/0)
500	15 ft	25 ft	39 ft	62 ft
700	11 ft	18 ft	28 ft	44 ft
1000	8 ft	12 ft	20 ft	31 ft
2000	4 ft	6 ft	10 ft	16 ft

Inverter/Charger DC Volt: 24

Watts	Wire Gauge			
	8	6	4	2
500	39 ft	62 ft	99 ft	157 ft
700	28 ft	44 ft	70 ft	112 ft
1000	19 ft	31 ft	49 ft	78 ft
2000	10 ft	15 ft	25 ft	39 ft
2400	8 ft	13 ft	21 ft	33 ft
3000	6 ft	10 ft	16 ft	26 ft

Inverter/Charger DC Volt: 36*

Watts	Wire Gauge			
	8	6	4	2
700	63 ft	100 ft	158 ft	252 ft
1000	44 ft	70 ft	111 ft	176 ft
2000	22 ft	35 ft	55 ft	88 ft
2400	18 ft	29 ft	46 ft	73 ft
3000	15 ft	23 ft	37 ft	59 ft
3600	12 ft	19 ft	31 ft	49 ft

Inverter/Charger DC Volt: 48

Watts	Wire Gauge			
	10	8	6	4
500	98 ft	156 ft	248 ft	394 ft
700	70 ft	111 ft	177 ft	281 ft
1000	49 ft	78 ft	124 ft	197 ft
2000	25 ft	39 ft	62 ft	98 ft
2400	20 ft	32 ft	52 ft	82 ft

Note on Labeling
Two symbols are used on the APS labels.
V → AC Voltage — : DC Voltage

* If your model accepts 4 conductors, simply double the acceptable cable lengths.

† NOTE: Acceptable power is directly related to cable length (i.e. - the shorter the cable, the better the performance)

Important Safety Instructions



SAVE THESE INSTRUCTIONS!

This manual contains important instructions and warnings that should be followed during the installation, operation and storage of all Tripp Lite Inverter/Chargers.

Location Warnings

- Install your Inverter/Charger (whether for a mobile or stationary application) in a location or compartment that minimizes exposure to heat, dust, direct sunlight and moisture.
- Although your Inverter/Charger is moisture resistant, it is NOT waterproof. Flooding the unit with water will cause it to short circuit and could cause personal injury due to electric shock. Never immerse the unit, and avoid any area where standing water might accumulate. Mounting should be in the driest location available.
- Leave a minimum of 2" clearance at front and back of the Inverter/Charger for proper ventilation. The heavier the load of connected equipment, the more heat will be generated by the unit.
- Do not install the Inverter/Charger directly near magnetic storage media, as this may result in data corruption.
- Do not install near flammable materials, fuel or chemicals.
- **Do not mount unit with its front or rear panel facing down (at any angle). Mounting in this manner will seriously inhibit the unit's internal cooling, eventually causing product damage not covered under warranty.**

Battery Connection Warnings

- The Inverter/Charger will not operate (with or without utility power) until batteries are connected.
- Multiple battery systems must be comprised of batteries of identical voltage, age, amp-hour capacity and type.
- Because explosive hydrogen gas can accumulate near batteries if they are not kept well ventilated, your batteries should not be installed (whether for a mobile or stationary application) in a "dead air" compartment. Ideally, any compartment would have some ventilation to outside air.
- Sparks may result during final battery connection. Always observe proper polarity as batteries are connected.
- Do not allow objects to contact the two DC input terminals. Do not short or bridge these terminals together. Serious personal injury or property damage could result.

Equipment Connection Warnings

Use of this equipment in life support applications where failure of this equipment can reasonably be expected to cause the failure of the life support equipment or to significantly affect its safety or effectiveness is not recommended. Do not use this equipment in the presence of a flammable anesthetic mixture with air, oxygen or nitrous oxide.

- Corded models: Do not modify the Inverter/Charger's plug or receptacle in a way that eliminates its ground connection. Do not use power adapters that will eliminate the plug's ground connection.
- Connect your Inverter/Charger only to a properly grounded AC power outlet or hardwired source. Do not plug the unit into itself; this will damage the device and void your warranty.
- You may experience uneven performance results if you connect a surge suppressor, line conditioner or UPS system to the output of the Inverter/Charger.

Operation Warnings

- Your Inverter/Charger does not require routine maintenance. Do not open the device for any reason. There are no user serviceable parts inside.
- Potentially lethal voltages exist within the Inverter/Charger as long as the battery supply and/or AC input are connected. During any service work, the battery supply and AC input connection should therefore be disconnected.
- Do not connect or disconnect batteries while the Inverter/Charger is operating in either inverting or charging mode. Operating Mode Switch should be in the OFF position. Dangerous arcing may result.

Feature Identification

Identify the premium features on your specific model and quickly locate instructions on how to maximize their use.

- 1 Configuration DIP Switches:** optimize Inverter/Charger operation depending on your application. See pages 6-7 for setting instructions.
- 2 Operating Mode Switch:** controls Inverter/Charger operation. The “AUTO/REMOTE” setting ensures your equipment receives constant, uninterrupted AC power. It also enables the Inverter/Charger to be remotely monitored and controlled with an optional remote module (Tripp Lite model APSRM2, sold separately or included with select models). The “CHARGE ONLY” setting allows your batteries to return to full charge faster by turning the inverter off which halts battery discharging. See page 5 for setting instructions.
- 3 Operation Indicator Lights:** intuitive “traffic light” signals show whether the Inverter/Charger is operating from AC line power or DC battery power. It also warns you if the connected equipment load is too high. See page 5 for instructions on reading indicator lights.
- 4 Battery Indicator Lights:** intuitive “traffic light” signals show approximate charge level of your battery. See page 5 for instructions on reading indicator lights.
- 5 DC Power Terminals:** connect to your battery terminals. See page 10 for connection instructions.
- 6 AC Receptacles (not on hardwire models):** allow you to connect equipment that would normally be plugged into a utility outlet.
- 7 AC Input Cord (not on hardwire models):** connects the Inverter/Charger to any source of utility- or generator-supplied AC power. See page 11 for connection instructions.
- 8 Hardwire AC Input/Output Terminal Strip (not on corded models):** securely connects the Inverter/Charger to facility or vehicle electrical system. See page 11 for connection instructions.
- 9 Resettable Circuit Breakers:** protect your Inverter/Charger against damage due to overload. See page 5 for resetting instructions.
- 10 Remote Control Module Connector:** allows remote monitoring and control with an optional module (Tripp Lite model APSRM2, sold separately or included with select models). See remote module owner’s manual for connection instructions.
- 11 Battery Charge Conservator (Load Sense) Control (not on 612 models):** conserves battery power by setting the low-load level at which the Inverter/Charger’s inverter automatically shuts off. See page 7 for setting instructions.
- 12 Main Ground Lug:** properly grounds the Inverter/Charger to earth ground or to vehicle or boat grounding system. See page 10 for connection instructions.
- 13 Thermostatically-Controlled Cooling Fan:** quiet, efficient fan regulates internal temperature and prolongs equipment service life. Fan runs intermittently depending on temperature and load.
- 14 DC Power Terminal Cover Plate**
- 15 Hardwire AC Input/Output Cover Plate**
- 16 Battery Temperature Sensing Connector (select models):** prolongs battery life by adjusting charge based on battery temperature. Use with cable (included on select models). See page 7 for details.
- 17 Voltage Regulation Indicator Lights (available on select models):** shows when the Inverter/Charger is automatically “boosting” abnormally low AC voltage or “cutting” abnormally high AC voltage without relying on battery power. This function is automatic and requires no action on the user’s part.
- 18 Redundant Switch/Indicator Light Panel (available on select models):** additional top mounted switch/indicator light panel allows easy control and monitoring when Inverter/Charger is mounted.

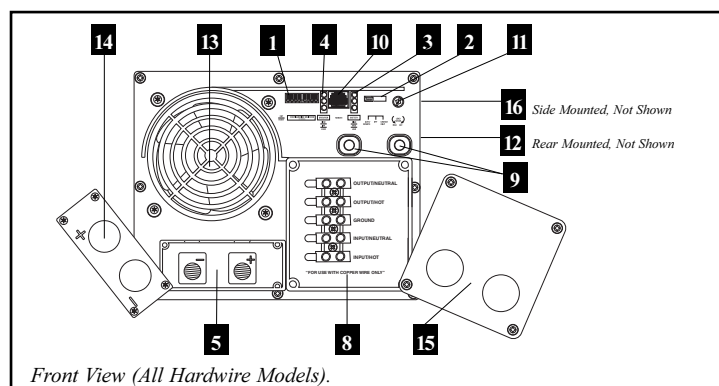
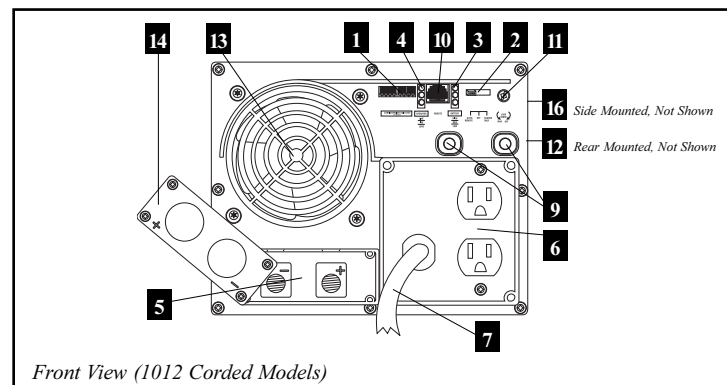
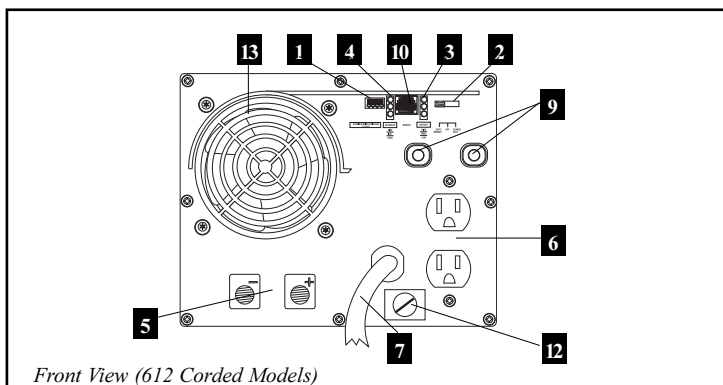

Operation

Switch Modes

After configuring, mounting and connecting your Inverter/Charger, you are able to operate it by switching between the following operating modes as appropriate to your situation:

AUTO/REMOTE: Switch to this mode when you need constant, uninterrupted AC power for connected appliances and equipment. The Inverter/Charger will continue to supply AC power to connected equipment and to charge your connected batteries while utility- or generator-supplied AC power is present. Since the inverter is ON (but in Standby) in this mode, it will automatically switch to your battery system to supply AC power to connected equipment in the absence of a utility/generator source or in over/under voltage situations. "AUTO/REMOTE" also enables an optional remote control module (Tripp Lite model APSRM2, sold separately or included with select models) to function when connected to the unit. This setting also allows operation of the Redundant Operating Mode Switch mounted on the top panel of select models

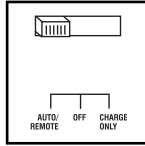

CHARGE ONLY: Switch to this mode when you are not using connected appliances and equipment in order to conserve battery power by disabling the inverter. The Inverter/Charger will continue to supply AC power to connected equipment and charge connected batteries while utility- or generator-supplied AC power is present. However, since the inverter is OFF in this mode, it WILL NOT supply AC power to connected equipment in the absence of a utility/generator source or in over/under voltage situations.

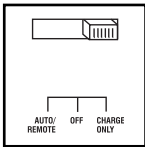

OFF: Switch to this mode to shut down the Inverter/Charger completely, preventing the inverter from drawing power from the batteries, and preventing utility AC from passing through to connected equipment or charging the batteries. Use this switch to automatically reset the unit if it shuts down due to overload or overheating. First remove the excessive load or allow the unit to sufficiently cool (applicable to your situation). Switch to "OFF", then back to "AUTO/REMOTE" or "CHARGE ONLY" as desired. If unit fails to reset, remove more load or allow unit to cool further and retry. Use an optional remote control module (Tripp Lite model APSRM2, sold separately or included with select models) to reset unit due to overload only.

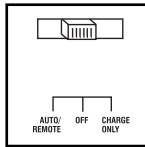

Indicator Lights

Your Inverter/Charger (as well as an optional Tripp Lite Remote Control Module, sold separately or included with select models) is equipped with a simple, intuitive, user-friendly set of indicator lights. These easily-remembered "traffic light" signals will allow you, shortly after first use, to tell at a glance the charge condition of your batteries, as well as ascertain operating details and fault conditions.

LINE Green Indicator: If the operating mode switch is set to "AUTO/REMOTE," this light will ILLUMINATE CONTINUOUSLY when your connected equipment is receiving continuous AC power supplied from a utility/generator source.

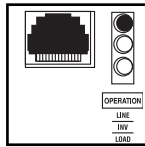

If the operating mode switch is set to "CHARGE ONLY," this light will FLASH to alert you that the unit's inverter is OFF and will NOT supply AC power in the absence of a utility/generator source or in over/under voltage situations.

INV (Inverting) Yellow Indicator: This light will ILLUMINATE CONTINUOUSLY whenever connected equipment is receiving battery-supplied, inverted AC power (in the absence of a utility/generator source or in over/under voltage situations). This light will be off when AC power is supplying the load. This light will FLASH to alert you if the load is less than the Battery Charge Conservator (Load Sense) setting.

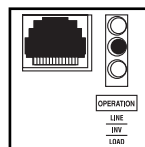

LOAD Red Indicator: This red light will ILLUMINATE CONTINUOUSLY whenever the inverter is functioning and the power demanded by connected appliances and equipment exceeds 100% of load capacity. The light will FLASH to alert you when the inverter shuts down due to a severe overload or overheating. If this happens, turn the operating mode switch "OFF"; remove the overload and let the unit cool. You may then turn the operating mode switch to either "AUTO/REMOTE" or "CHARGE ONLY" after it has adequately cooled. This light will be off when AC power is supplying the load.

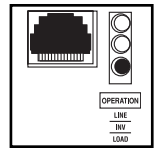

BATTERY Indicator Lights: These three lights will illuminate in several sequences to show the approximate charge level of your connected battery bank and alert you to two fault conditions:

Approximate Battery Charge Level*

Indicator Illuminated	Battery Capacity (Charging/Discharging)
1 Green	91%–Full
2 Green & Yellow	81%–90%
3 Yellow	61%–80%
4 Yellow & Red	41%–60%
5 Red	21%–40%
6 All three lights off	1%–20%
7 Flashing red	0% (Inverter shutdown)

* Charge levels listed are approximate. Actual conditions vary depending on battery condition and load.

Fault Condition

Indicator Illuminated	Fault Condition
1 All three lights flash slowly*	Excessive discharge (Inverter shutdown)
2 All three lights flash quickly**	Overcharge (Charger shutdown)

* Approximately 1/2 second on, 1/2 second off. See Troubleshooting section. ** Approximately 1/4 second on, 1/4 second off. May also indicate a battery charger fault exists. See Troubleshooting section.

Voltage Regulation Indicator Lights (available on select models): these green lights will illuminate to indicate when the Inverter/Charger is automatically "boosting" abnormally low AC voltage or "cutting" abnormally high AC voltage without relying on battery power. This function is automatic and requires no action on the user's part.

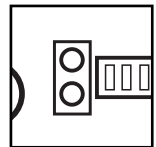

Resetting Your Inverter/Charger to Restore AC Power

Your Inverter/Charger may cease supplying AC power or DC charging power in order to protect itself from overload or to protect your electrical system. To restore normal functioning:

Overload Reset: Switch operating mode switch to "OFF" and remove some of the connected electrical load (ie: turn off some of the AC devices drawing power which may have caused the overload of the unit). Wait one minute, then switch operating mode switch back to either "AUTO/REMOTE" or "CHARGE ONLY."

Output Circuit Breaker Reset: Alternatively, check output circuit breaker(s) on the unit's front panel. If tripped, remove some of the electrical load, then wait one minute to allow components to cool before resetting the circuit breaker. See Troubleshooting for other possible reasons AC output may be absent.

See page 11 for Redundant Switch/Indicator Light Panel

Configuration

Set Configuration DIP Switches

Using a small tool, set the Configuration DIP Switches (located on the front panel of your unit, see diagram) to optimize Inverter/Charger operation depending on your application. 612 models have one set of four DIP Switches (Group A). All other models include an additional set of four DIP switches (Group B) to configure additional operational functions.

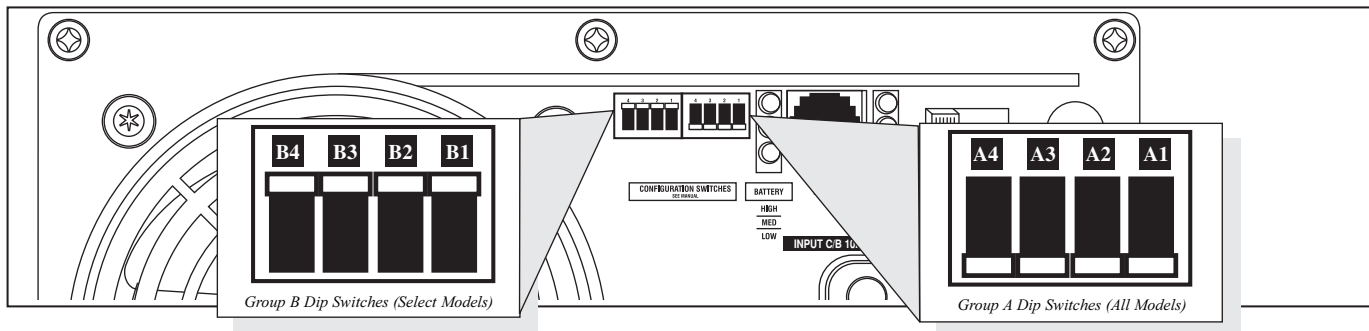

Group A DIP Switches (All Models)

A1 Select Battery Type—REQUIRED

CAUTION: The Battery Type DIP Switch setting must match the type of batteries you connect, or your batteries may be degraded or damaged over an extended period of time. See "Battery Selection," p. 8 for more information.



Battery Type	Switch Position
Gel Cell (Sealed) Battery	Up
Wet Cell (Vented) Battery	Down (factory setting)

A2 Select High AC Input Voltage Point for Switching to Battery—OPTIONAL*

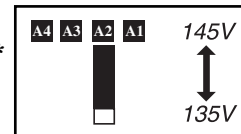

Voltage	Switch Position
145V	Up
135V	Down (factory setting)

A4 A3 Select Low AC Input Voltage Point for Switching to Battery—OPTIONAL*

Voltage	Switch Position
105V	#A4 Up & #A3 Up
95V	#A4 Up & #A3 Down
85V	#A4 Down & #A3 Up
75V	#A4 Down & #A3 Down (factory setting)

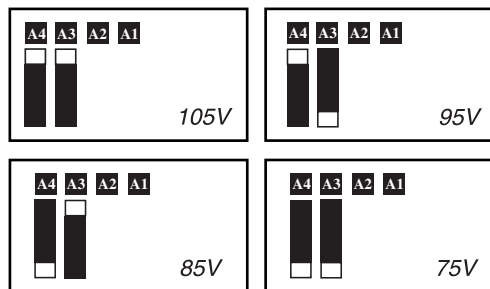

* Most of your connected appliances and equipment will perform adequately when your Inverter/Charger's High AC Input Voltage Point is left in the factory setting and its Low AC Voltage Input Point is set to 95V. However, if the unit frequently switches to battery power due to momentary high/low line voltage swings that would have little effect on equipment operation, you may wish to adjust these settings. By increasing the High AC Voltage Point and/or decreasing the Low AC Voltage Point, you will reduce the number of times your unit switches to battery due to voltage swings.

Group B DIP Switches (Select Models)

B1 B2 Select Load Sharing—OPTIONAL (Not on 612 Models)

Your Inverter/Charger features a high-output battery charger that can draw a significant amount of AC power from your utility source or generator when charging at its maximum rate. If your unit is supplying its full AC power rating to its connected heavy electrical loads at the same time as this high charging occurs, the AC input circuit breaker could trip, resulting in the complete shut off of pass-through utility power.

To reduce the chance of tripping this breaker, Inverter/Chargers may be set to automatically limit the charger output. This keeps the sum of the unit's AC load and charge power within the circuit breaker rating. This charger-limiting function has four settings, allowing you to reduce the charger's draw lower and lower, as needed, if the AC input circuit breaker keeps tripping under the normal AC loads of devices you have connected downline from the unit. The figures on the next page show how to set your DIP Switches to determine how heavy the connected load can be on your Inverter/Charger before charger-limiting begins.

Configuration *(continued)*

Select Battery Charger-Limiting Points—OPTIONAL (Not on 612 Models)

Most Limiting (#B1 & #B2 Up, factory setting): Charger-limiting takes effect the moment any 120V AC load is applied; charger output falls gradually from full output at no 120V load passing through to no output at full load.

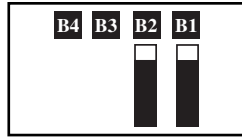

Less Limiting (#B1 Down & #B2 Up): Charger-limiting begins when the Inverter/Charger's load reaches 33% of the Inverter/Charger's load rating. Charger output falls gradually from full output at 33% of the Inverter/Charger's load rating to about 33% of full output at full load.

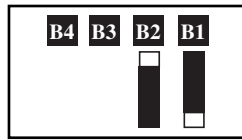

Least Limiting (#B1 Up & #B2 Down): Charger-limiting begins at when the Inverter/Charger's load reaches 66% of the Inverter/Charger's load rating. Charger output falls gradually from full output at 66% of the Inverter/Charger's load rating to about 66% of full output at full load.

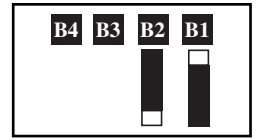

No Limiting (#B1 & #B2 Down): No charger-limiting occurs at any load size.

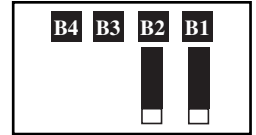

B3 Select Equalize Battery Charge—OPTIONAL (Not on 612 Models)

This DIP Switch is momentarily engaged to begin the process of equalizing the charge state of your battery's cells by time-limited overcharge of all cells. This can extend the useful life of certain types of batteries; consult with your battery's manufacturer to determine if your batteries could benefit from this process. The charge equalization process is automatic; once started, it can only be stopped by removing the input power.



Setting Procedure

- Move to "Equalize" (DOWN) position for three seconds.
- Move to "Reset" (UP) position and leave it there. This is the factory default setting.

CAUTION: Do not leave DIP switch #3 in the down position after beginning process. Battery charge equalization should only be performed in strict accordance with the battery manufacturer's instructions and specifications.

Battery Charge	Switch Position
Reset	Up (factory setting)
Equalize	Down—momentarily

B4 Set Battery Charging Amps—OPTIONAL (Not on 612 Models)

Check specifications for your unit's high- and low-charging amp options. By setting on high charging, your batteries will charge at maximum speed. When setting on low charging, you lengthen the life of your batteries (especially smaller ones).

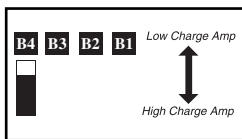

Battery Charger	Switch Position
Low Charge Amps	Up (factory setting)
High Charge Amps	Down

CAUTION: When switching to the High Charge Amp setting, the user must ensure that the amp hour capacity of their battery system exceeds the amperage of the High Charge Amp setting or the batteries may be damaged or degraded.

Set Battery Charge Conserver (Load Sense) Control—OPTIONAL (All models except 612 models)

In order to save battery power, the unit's inverter automatically shuts off in the absence of any power demand from connected equipment or appliances (the electrical load). When the Inverter/Charger detects a load, it automatically turns its inverter function on. Users may choose the minimum load the Inverter/Charger will detect by adjusting the Battery Charge Conserver Control (see diagram). Using a small tool, turn the control clockwise to lower the minimum load that will be detected, causing the inverter to turn on for smaller loads. When the control is turned fully clockwise, the inverter will operate even when there is no load. Turn the control counterclockwise to increase the minimum load that will be detected, causing the inverter to stay off until the new minimum load is reached.

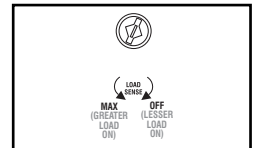

NOTE: The factory setting for the control is fully clockwise. However, based on the threshold load to which you'd like the inverter to respond, you should adjust the control counterclockwise to reduce its sensitivity until the inverter is active only when connected equipment or appliances are actually in use.

Connect Remote Control—Optional (All models)

All models feature an 8-conductor telephone style receptacle on the front panel for use with an optional remote control module (Tripp Lite model APSRM2, sold separately or included with select models). The remote module allows the Inverter/Charger to be mounted in a compartment or cabinet out of sight, while operated conveniently from a remote location. See instructions packed with the remote control module.

Connect Battery Temperature Sensing Cable—OPTIONAL (select models)

The battery temperature sensing function prolongs battery life by adjusting the charge float voltage level based on battery temperature. Connect the sensor cable (the cable, included with select models, has an RJ style connector on one end and a black sensor on the other) to the RJ style jack located on the side of the Inverter/Charger labeled "Remote Temp. Sense." Affix the sensor to the side of your battery below the electrolyte level. To guard against false readings due to ambient temperature, place the sensor between batteries, if possible, or away from sources of extreme heat or cold. If the sensor cable is not used, the Inverter/Charger will charge according to its default 25° C values.

Battery Selection

Select Battery Type

Select "Deep Cycle" batteries to enjoy optimum performance from your Inverter/Charger. Batteries of either Wet-Cell (vented) or Gel-Cell /Absorbed Glass Mat (sealed) construction are ideal. 6-volt "golf cart," Marine Deep-Cycle or 8D Deep-Cycle batteries are also acceptable. You must set the Inverter/Charger's Battery Type DIP Switch (see Configuration section for more information) to match the type of batteries you connect or your batteries may be degraded or damaged over an extended period of time.

Match Battery Amp-Hour Capacity to Your Application







Select a battery or system of batteries that will provide your Inverter/Charger with proper DC voltage and an adequate amp-hour capacity to power your application. Even though Tripp Lite Inverter/Chargers are highly-efficient at DC-to-AC inversion, their rated output capacities are limited by the total amp-hour capacity of connected batteries plus the output of an alternator when one is used.

Example

• STEP 1) Determine Total Wattage Required

Add the wattage ratings of all equipment you will connect to your Inverter/Charger. Wattage ratings are usually listed in equipment manuals or on nameplates. If your equipment is rated in amps, multiply that number times AC utility voltage to estimate watts. (Example: a ¼ in. drill requires 2½ amps. 2½ amps × 120 volts = 300 watts.)

NOTE: Your Inverter/Charger will operate at higher efficiencies at about 75% - 80% of nameplate rating.

Tools				
¼" Drill	Orbital Sander	Cordless Tool Charger		
				
300W	+	220W	+	20W
				= 540W
Appliances				
Blender	Color TV	Laptop Computer		
				
300W	+	140W	+	100W
				= 540W

• STEP 2) Determine DC Battery Amps Required

Divide the total wattage required (from step 1, above) by the battery voltage (i.e. 12, 24, 36 or 48) to determine the DC amps required.

$$540 \text{ watts} \div 12\text{V} = 45 \text{ DC Amps}$$

• STEP 3) Estimate Battery Amp-Hours Required

Multiply the DC amps required (from step 2, above) by the number of hours you estimate you will operate your equipment exclusively from battery power before you have to recharge your batteries with utility- or generator-supplied AC power. Compensate for inefficiency by multiplying this number by 1.2. This will give you a rough estimate of how many amp-hours of battery power (from one or several batteries) you should connect to your Inverter/Charger.

NOTE: Battery amp-hour ratings are usually given for a 20-hour discharge rate. Actual amp-hour capacities are less when batteries are discharged at faster rates. For example, batteries discharged in 55 minutes provide only 50% of their listed amp-hour ratings, while batteries discharged in 9 minutes provide as little as 30% of their amp-hour ratings.

$$45 \text{ DC Amps} \times 5 \text{ Hrs. Runtime} \\ \times 1.2 \text{ Inefficiency Rating} = 270 \text{ Amp-Hours}$$

• STEP 4) Estimate Battery Recharge Required, Given Your Application

You must allow your batteries to recharge long enough to replace the charge lost during inverter operation or else you will eventually run down your batteries. To estimate the minimum amount of time you need to recharge your batteries given your application, divide your required battery amp-hours (from step 3, above) by your Inverter/Charger's rated charging amps (see Specifications section).

NOTE: For Tripp Lite Inverter/Chargers providing 1000 watts or less of continuous AC power, a full-size battery will normally allow sufficient power for many applications before recharging is necessary. For mobile applications, if a single battery is continuously fed by an alternator at high idle or faster, then recharging from utility or generator power may not be necessary. For Tripp Lite Inverter/Chargers over 1000 watts used in mobile applications, Tripp Lite recommends you use at least two batteries, if possible fed by a heavy-duty alternator anytime the vehicle is running. Tripp Lite Inverter/Chargers will provide adequate power for ordinary usage within limited times without the assistance of utility or generator power. However, when operating extremely heavy electrical loads at their peak in the absence of utility power, you may wish to "assist your batteries" by running an auxiliary generator or vehicle engine, and doing so at faster than normal idling.

$$270 \text{ Amp-Hours} \div 30 \text{ Amps} \\ \text{Inverter/Charger Rating} = 9 \text{ Hours Recharge}$$

Mounting



WARNING! Mount your Inverter/Charger BEFORE DC battery and AC power connection. Failure to follow these instructions may lead to personal injury and/or damage to the Inverter/Charger and connected systems.

Tripp Lite manufactures a variety of different Inverter/Chargers with a variety of different mounting options for use in vehicular or non-vehicular applications. Tripp Lite recommends permanent mounting of your Inverter/Charger in any of the configurations illustrated below. User must supply mounting hardware and is responsible for determining if the hardware and mounting surface are suitable to support the weight of the Inverter/Charger. Contact Tripp Lite if you require further assistance in mounting your Inverter/Charger.

Vehicular and Non-Vehicular Horizontal Mount (612 models only)

A Using the measurements from the diagram, install two user-supplied $\frac{1}{4}$ " (6 mm) fasteners into a rigid horizontal surface, leaving the heads slightly raised. **B** Slide the Inverter/Charger back over the fasteners to engage the mounting slots molded on the bottom of the Inverter/Charger cabinet. **C** Install and tighten two user-supplied $\frac{1}{4}$ " (6 mm) fasteners into the mounting feet molded on the front of the Inverter/Charger cabinet.

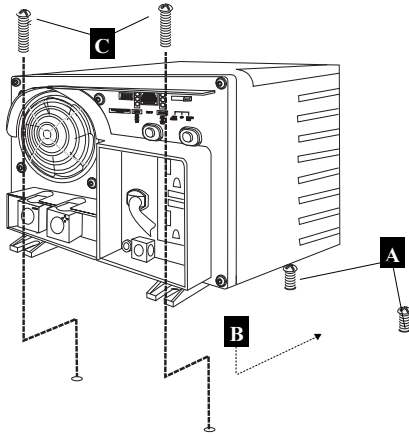

Vehicular and Non-Vehicular Horizontal Mount (All models except 612)

A Using the measurements from the diagram, install two user-supplied $\frac{1}{4}$ " (6 mm) fasteners into a rigid surface, leaving the heads slightly raised. **B** Slide the Inverter/Charger forward over the fasteners to engage the mounting feet molded on the front of the Inverter/Charger cabinet. **C** Install and tighten two user-supplied $\frac{1}{4}$ " (6 mm) fasteners into the mounting feet molded on the rear of the Inverter/Charger cabinet. The rear feet extend beyond the unit's cabinet to provide for adequate ventilation space behind the cooling fan(s); they should not be removed.

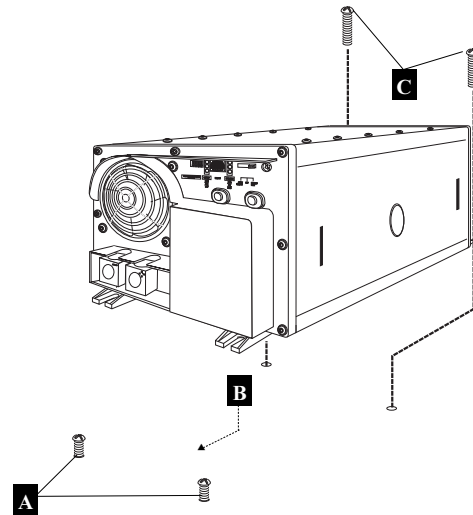

Note: APS model cabinets may have different front panel features, but all have identical mounting.

Battery Connection

Connect your Inverter/Charger to your batteries using the following procedures:

• **Connect DC Wiring:** Though your Inverter/Charger is a high-efficiency converter of electricity, its rated output capacity is limited by the length and gauge of the cabling running from the battery to the unit. Use the shortest length and largest diameter cabling (maximum 2/0 gauge) to fit your Inverter/Charger's DC Input terminals. Shorter and heavier gauge cabling reduces DC voltage drop and allows for maximum transfer of current. Your

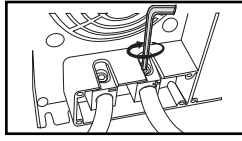

DC Connectors

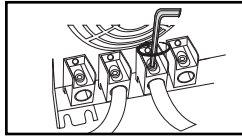

Dual DC Connectors (See note at bottom of the page)

Inverter/Charger is capable of delivering peak wattage at up to 200% of its rated continuous wattage output for brief periods of time. See Specifications page for details. Heavier gauge cabling should be used when continuously operating heavy draw equipment under these conditions. Tighten your Inverter/Charger and battery terminals to approximately 3.5 Newton-meters of torque to create an efficient connection and to prevent excessive heating at this connection. Insufficient tightening of the terminals could void your warranty. See **Specifications page for Minimum Recommended Cable Sizing Chart.**

• **Connect Ground:** Using a #8 AWG wire or larger directly connect the Main Ground

Lug to the vehicle's chassis or earth ground. See the Feature Identification section to locate the Main Ground Lug on your specific Inverter/Charger model. All installations must comply with national and local codes and ordinances.

• **Connect Fuse:** NEC (National Electrical Code) article 551 requires that you connect all of your Inverter/Charger's positive DC Terminals directly to a UL-listed fuse(s) and fuse block(s) within 18 inches of the battery. The fuse's rating must equal or exceed the Minimum DC Fuse Rating listed in your Inverter/Charger's specifications. See Specifications for fuse and fuse block recommendations. See diagrams below for proper fuse placement.



WARNING! • Failure to properly ground your Inverter/Charger to a vehicle's chassis or earth ground may result in a lethal electrical shock hazard.

• Never attempt to operate your Inverter/Charger by connecting it directly to output from an alternator rather than a battery or battery bank.

• Observe proper polarity with all DC connections.

Non-Vehicular or Vehicular

Non-vehicular applications include stationary configurations as well as mobile configurations that are not integrated into a vehicle's electrical system. In a parallel connection, your Inverter/Charger's Nominal DC Input Voltage (listed in the Specifications section as either 12, 24, 36 or 48) **must match** the voltage of your battery or batteries (12, 24, 36 or 48). For example, a 12V DC Inverter/Charger would require 12V DC from your battery system.

In a series connection, your Inverter/Charger's Nominal DC Input Voltage **must match** the number of batteries multiplied by their voltage. For example, a 24V DC Inverter/Charger would require either two 12V batteries connected in series ($24 = 2 \times 12$) or four 6V batteries connected in series ($24 = 4 \times 6$).

In vehicular applications, your Inverter/Charger's Nominal DC Input Voltage **must match** the voltage of your battery or batteries—12 Volts. Although it is possible to connect your Inverter/Charger to the main battery within your vehicle's electrical system, in the normal vehicular context, the Inverter/Charger is connected to one or more dedicated auxiliary (house) batteries which are isolated from the drive system to prevent possible draining of the main battery.

Contact Tripp Lite technical support for assistance with additional parallel, series or series/parallel connections.

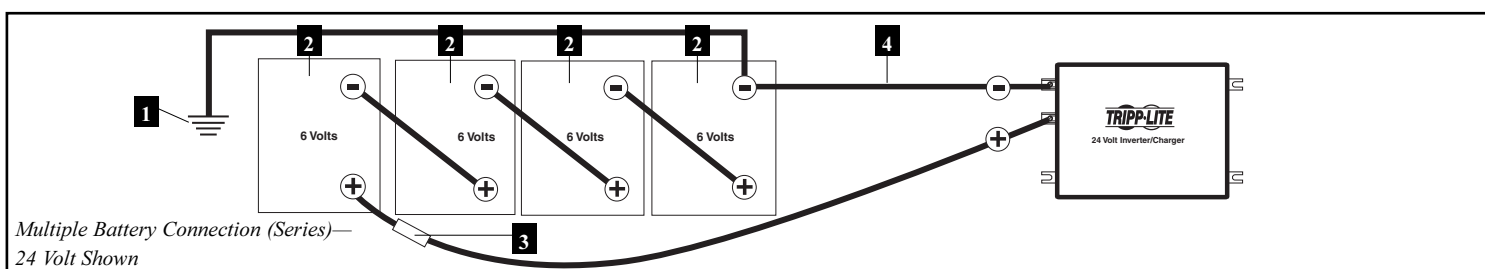
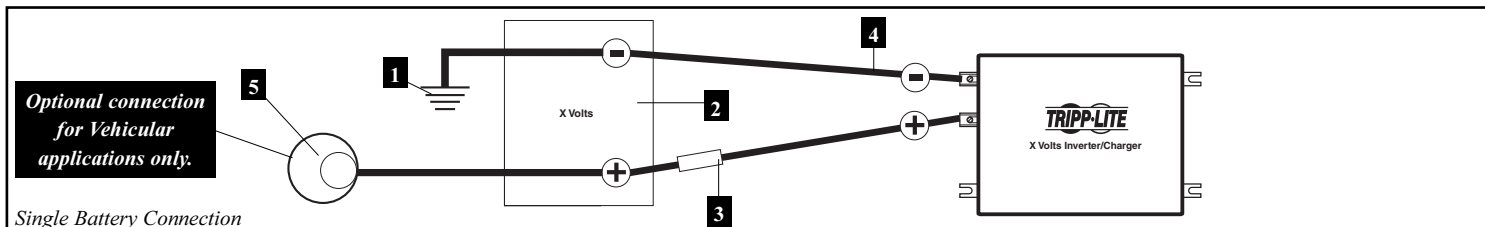

Note: X=Your Inverter/Charger's Nominal DC Input Voltage (listed in the specifications section as either 12, 24, 36 or 48)

1 Earth or Vehicle/Boat Battery Ground 2 Battery 3 UL-Listed Fuse & Fuse Block (mounted within 18 inches of the battery) 4 Large Diameter

Cabling, Maximum 2/0 Gauge to Fit Terminals 5 Alternator (for vehicle or boat connection only)

NOTE: Select models include two positive and two negative DC terminals. Using the same connection architecture illustrated in the diagrams, run two 2/0 gauge cables from the Inverter/Charger's two negative terminals to the battery's single negative terminal; run two 2/0 gauge cables from the Inverter/Charger's two positive terminals, through two UL-listed fuses and fuse blocks, or equivalent, (one on each cable), to the battery's single positive terminal. Use the equivalent of two 2/0 cables in all other connections within the battery system. Connection to two DC Terminals: It is acceptable to use two cables to connect your battery to only one positive and one negative DC terminal, however, your Inverter/Charger will provide reduced output power. It doesn't make a difference which positive and negative terminal you choose for the connection because both positive terminals are internally bonded and both negative terminals are also internally bonded. In this connection, you must run one positive cable through one user-supplied UL-listed fuse and fuse block.

AC Input/Output Connection

To avoid overloading your Inverter/Charger, be sure to match the power requirements of the equipment you plan to run at any one time (add their total watts) with the output wattage capacity of your Inverter/Charger model (see Specifications). When figuring the power requirements of your equipment, do not confuse “continuous” wattage with “peak” wattage ratings. Most electric motors require extra power at start-up (“peak” wattage) than required to run continuously after start-up, sometimes over 100% more. Some motors, such as in refrigerators and pumps, start and stop intermittently according to demand, requiring “peak” wattage at multiple, unpredictable times during operation.

• DoubleBoost™ Feature

Tripp Lite Inverter/Chargers deliver up to twice their nameplate rated wattage for up to 10 seconds,* providing the extra power needed to cold start heavy-duty tools and equipment.

• OverPower™ Feature

Tripp Lite Inverter/Chargers deliver up to 150% of their nameplate rated wattage for up to 1 hour,* providing plenty of reserve power to reliably support tools and equipment longer.

** Actual duration depends on battery age, battery charge level and ambient temperature.*

Connection for Models with Cords and Receptacles

Plug the Inverter/Charger’s AC input cord into an outlet providing 120V AC, 60Hz. power. Make sure that the circuit you connect your Inverter/Charger to has adequate overload protection, such as a circuit breaker or a fuse. To make use of AC output (either utility/generator pass-through power or inverter power) simply plug your equipment into the Inverter/Charger’s AC receptacles. Any equipment you connect to it will benefit from your Inverter/Charger’s built-in **ISOBAR®** surge protection!



Warning! Consult a qualified electrician and follow all applicable electrical codes and requirements for hardwire connection. Disconnect both DC input and AC utility supply before attempting hardwiring.

Connection for Models with Hardwire Terminals

Remove the screws and cover plate over the hardwire terminal box. Remove the knockout covers closest to the desired electrical source and to your equipment. Attach ½" diameter conduits (user-supplied) to the knockouts and thread wires through. Connect the conduits to each other with the ground bond connection supplied.

Ground*

- Connect the incoming and outgoing ground wires to the ground (green) terminal **1**.

AC Input

- Connect the incoming hot wire to the input hot (brown) terminal **2**.
- Connect the incoming neutral wire to the input neutral (blue) terminal **3**.

AC Output

- Connect the outgoing hot wire to the output hot (black) terminal **4**.
- Connect the outgoing neutral wire to the output neutral (white) terminal **5**.
- Replace cover plate and tighten screws.

** If the incoming conduit only contains two wires (hot and neutral), the incoming conduit must be bonded to the main ground lug on the unit. In any case, the incoming conduit must be bonded to earth or vehicle ground, and the incoming conduit must be bonded to the outgoing conduit.*

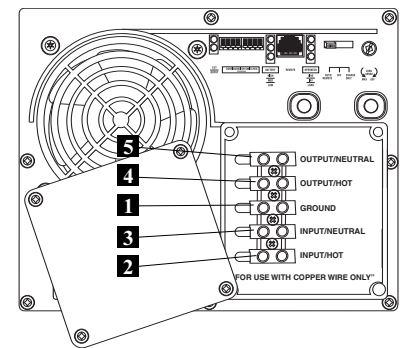

Redundant Switch/Indicator Light Panel (available on select models)

Additional top mounted switch/indicator light panel allows easy control and monitoring when Inverter/Charger is mounted. Activate by setting Operating Mode Switch (located on the front panel) to “AUTO/REMOTE.” Top panel indicator light function is identical to the front panel indicator lights. Top panel “AUTO” and “CHRG ONLY” (Charge Only) switch settings are identical to the front panel Operating Mode Switch settings.

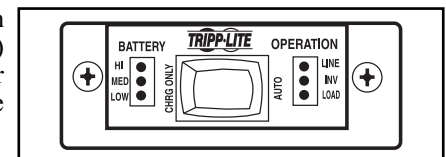

Service

If you are returning your Inverter/Charger to Tripp Lite, please pack it carefully, using the ORIGINAL PACKING MATERIAL that came with the unit. Enclose a letter describing the symptoms of the problem. If the Inverter/Charger is within the warranty period, enclose a copy of your sales receipt. To obtain service you must obtain a Returned Material Authorization (RMA) number from Tripp Lite or an authorized Tripp Lite service center.

Maintenance

Your Inverter/Charger requires no maintenance and contains no user-serviceable or replaceable parts, but should be kept dry at all times. Periodically check, clean and tighten all cable connections as necessary, both at the unit and at the battery.

Troubleshooting

Try these remedies for common Inverter/Charger problems before calling for assistance. Call Tripp Lite Customer Service at (773) 869-1234 before returning your unit for service.

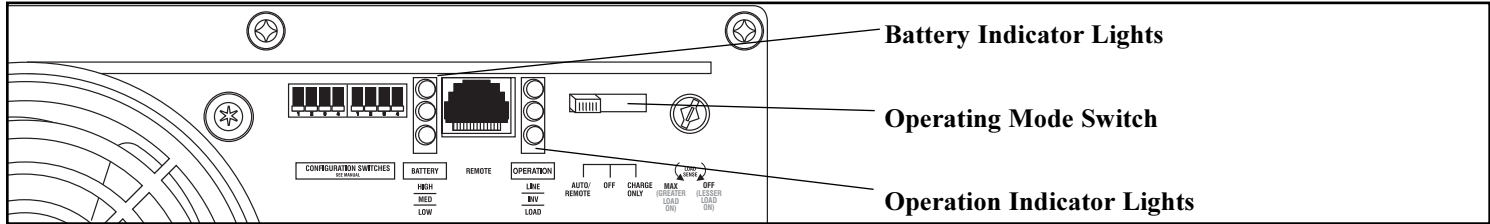

SYMPTOM	PROBLEMS	CORRECTIONS
No AC Output (All Indicator Lights Are OFF)	Unit is not properly connected to utility power.	Connect unit to utility power.
	Operating Mode Switch is set to "OFF" and AC input is present.	Set Operating Mode Switch to "AUTO/REMOTE" or "CHARGE ONLY."
	This is normal when the Operating Mode Switch is set to "CHARGE ONLY" and AC input is absent.	No correction is required. AC output will return when AC input returns. Set Operating Mode Switch to "AUTO/REMOTE" if you require AC output.
	Circuit breaker is tripped.	Reset circuit breaker.
	Unit has shut down due to battery overcharge (preventing battery damage). The problem may be with connected auxiliary chargers, if any, or with the unit's charger.	Disconnect any auxiliary chargers. Reset by moving Operating Mode Switch to "OFF." Wait 1 minute and switch to "AUTO/REMOTE" or "CHARGE ONLY." If unit remains in shutdown mode after several attempts to reset, contact Tripp Lite Customer Service for assistance.
	Unit has shut down due to excessive battery discharge.	Use an auxiliary charger* to raise battery voltage. Check external battery connections and fuse. Unit automatically resets when condition is cleared.
Battery Not Recharging (AC Input Present)	Unit has shut down due to overload.	Reduce load. Reset by moving Operating Mode Switch to "OFF." Wait 1 minute. Switch to "AUTO/REMOTE" or "CHARGE ONLY."
	Connected batteries are dead.	Check and replace old batteries.
	Battery fuse* is blown.	Check and replace fuse.*
	Battery cabling* is loose.	Check and tighten or replace cabling.*
	Unit has shut down due to battery overcharge (preventing battery damage). The problem may be with connected auxiliary chargers, if any, or with the unit's charger.	Disconnect any auxiliary chargers. Reset by moving Operating Mode Switch to "OFF." Wait 1 minute and switch to "AUTO/REMOTE" or "CHARGE ONLY." If unit remains in shutdown mode after several attempts to reset, contact Tripp Lite Customer Service for assistance.
All Three Battery Indicator Lights Are Slowly Flashing (½ Second Flashes)	Input circuit breaker is tripped.	Reset circuit breaker.
	Battery is excessively discharged.	Use an auxiliary charger* to raise battery voltage. Check external battery connections and fuse. Unit automatically resets when condition is cleared.
All Three Battery Indicator Lights Are Rapidly Flashing (¼ Second Flashes)	Battery is overcharged. Unit will shut down to prevent battery damage. The problem may be with connected auxiliary chargers, if any, or with the unit's charger.	Disconnect any auxiliary chargers. Reset by moving Operating Mode Switch to "OFF." Wait 1 minute and switch to "AUTO/REMOTE" or "CHARGE ONLY." If unit remains in shutdown mode after several attempts to reset, contact Tripp Lite Customer Service for assistance.
Red "LOW" Battery Indicator Light is Flashing	Battery voltage is low. Unit will automatically shut down after 5 seconds to protect battery from damage.	Make sure that AC power is present in order to recharge batteries. Reset by moving Operating Mode Switch to "OFF" then to "AUTO/REMOTE" or "CHARGE ONLY."
	False reading due to undersized or insufficiently connected DC cabling.	Use sufficient size DC cable sufficiently connected to the Inverter/Charger.
Red "LOAD" Operation Indicator Light Flashing	Inverter is overloaded. Unit will automatically shut down after 5 seconds.	Reduce load. Reset by moving Operating Mode Switch to "OFF." Wait 1 minute. Switch to "AUTO/REMOTE" or "CHARGE ONLY."
Green "BOOST" or "CUT" Indicator Lights (available on select models) Flashing	This is a normal function.	No action is required on the user's part.

* User-supplied.

Limited Warranty

Tripp Lite warrants its Inverter/Chargers to be free from defects in materials and workmanship for a period of one year (except for outside of U.S.A., Canada and Mexico—120 days) from the date of retail purchase by end user. Tripp Lite's obligation under this warranty is limited to repairing or replacing (at its sole option) any such defective products. To obtain service under this warranty you must obtain a Returned Material Authorization (RMA) number from Tripp Lite or an authorized Tripp Lite service center. Products must be returned to Tripp Lite or an authorized Tripp Lite service center with transportation charges prepaid and must be accompanied by a brief description of the problem encountered and proof of date and place of purchase. This warranty does not apply to equipment which has been damaged by accident, negligence or misapplication or has been altered or modified in any way, including opening of the unit's casing for any reason. This warranty applies only to the original purchaser who must have properly registered the product within 10 days of retail purchase.

EXCEPT AS PROVIDED HEREIN, TRIPP LITE MAKES NO WARRANTIES, EXPRESS OR IMPLIED, INCLUDING WARRANTIES OF MERCHANTABILITY AND FITNESS FOR A PARTICULAR PURPOSE. Some states do not permit limitation or exclusion of implied warranties; therefore, the aforesaid limitation(s) or exclusion(s) may not apply to the purchaser.

EXCEPT AS PROVIDED ABOVE, IN NO EVENT WILL TRIPP LITE BE LIABLE FOR DIRECT, INDIRECT, SPECIAL, INCIDENTAL OR CONSEQUENTIAL DAMAGES ARISING OUT OF THE USE OF THIS PRODUCT, EVEN IF ADVISED OF THE POSSIBILITY OF SUCH DAMAGE. Specifically, Tripp Lite is not liable for any costs, such as lost profits or revenue, loss of equipment, loss of use of equipment, loss of software, loss of data, costs of substitutes, claims by third parties, or otherwise.

WARRANTY REGISTRATION

Visit www.triplite.com/warranty today to register the warranty for your new Tripp Lite product. You'll be automatically entered into a drawing for a chance to win a FREE Tripp Lite product!

* No purchase necessary. Void where prohibited. Some restrictions apply. See website for details.

Regulatory Compliance Identification Numbers

For the purpose of regulatory compliance certifications and identification, your Tripp Lite product has been assigned a unique series number. The series number can be found on the product nameplate label, along with all required approval markings and information. When requesting compliance information for this product, always refer to the series number. The series number should not be confused with the marking name or model number of the product.

Tripp Lite has a policy of continuous improvement. Specifications are subject to change without notice.